

# Assembly Instructions

The package contains 9 sheets: three double and three single sheets.  
After assembly the trays are placed in up to 3 layers in the game box.  
Ordinary PVA glue is required when assembling each tray.  
Please make sure you dry-assemble each tray correctly before gluing it together.  
Please check [www.foldedspace.net](http://www.foldedspace.net) for general assembly tips.

## FS-NMSLD

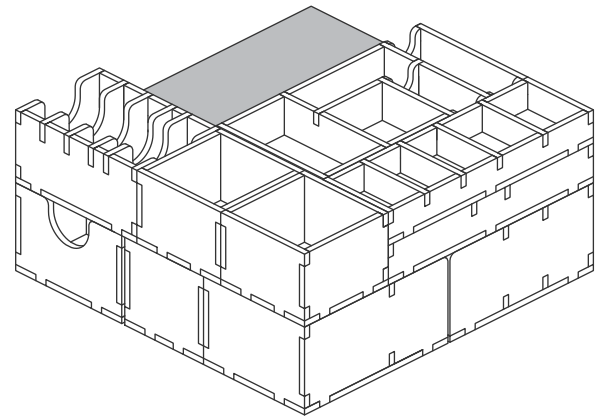

Sheet A1

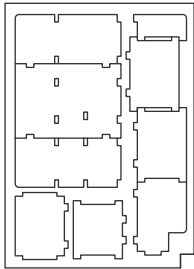

Sheet B1

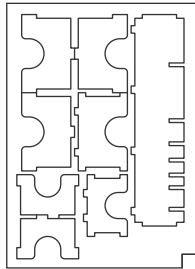

Sheet C1

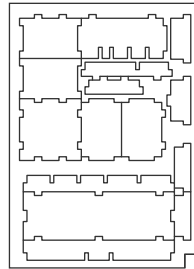

Sheet A2

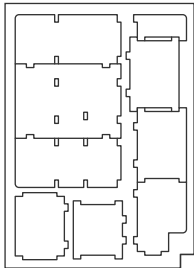

Sheet B2

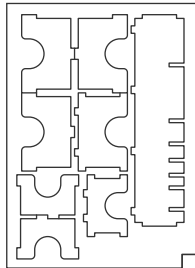

Sheet C2

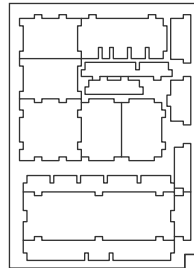

Sheet D

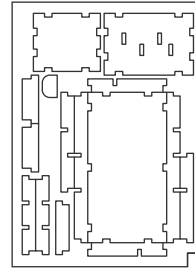

Sheet E

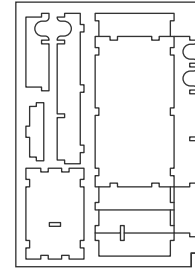

Sheet F

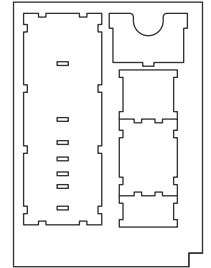

### Tray 1a, 1b

(the trays are identical)

Sheet C1, C2

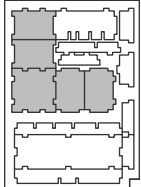

Step 1

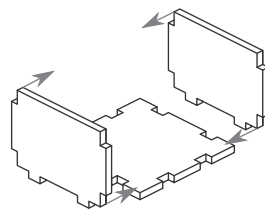

Step 2

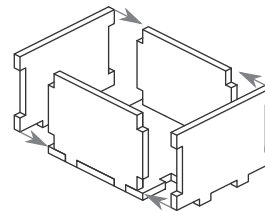

Finished tray

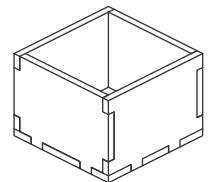

### Tray 2

Sheet A1, A2

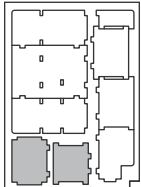

Sheet D

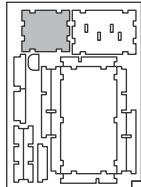

Step 1

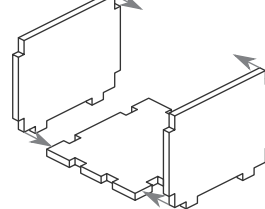

Step 2

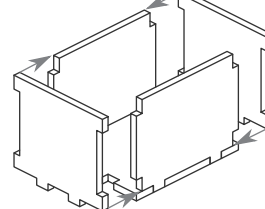

Finished tray

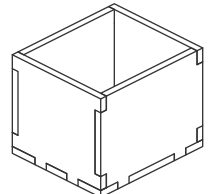

### Tray 3

Sheet A1, A2

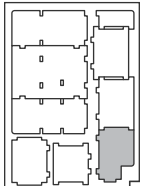

Sheet F

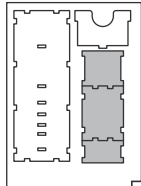

Step 1

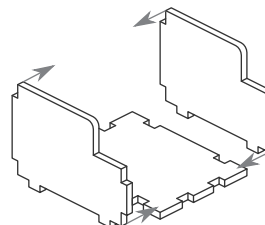

Step 2

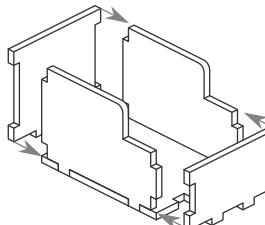

Finished tray

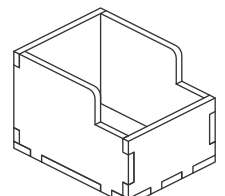

### Tray 4

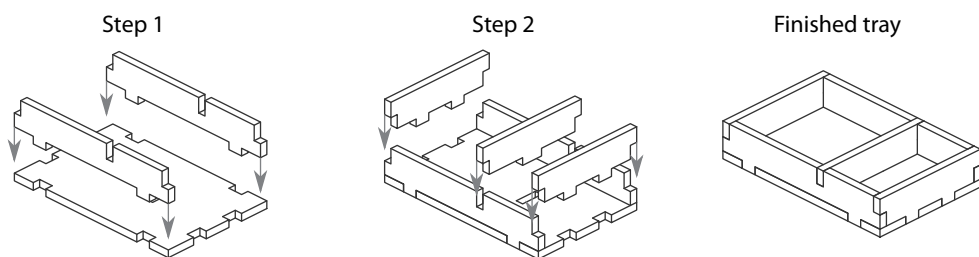
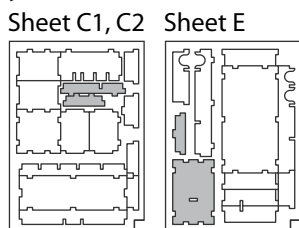

### Tray 5a, 5b

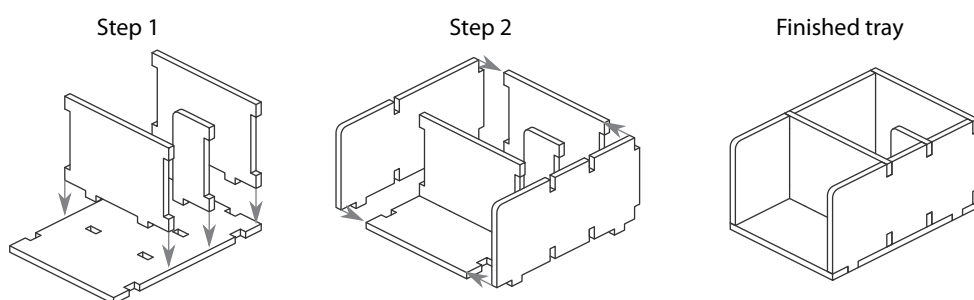
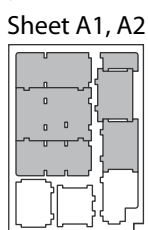

### Tray 6

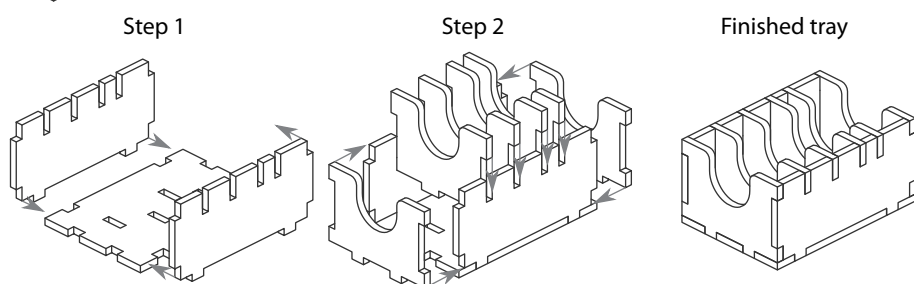
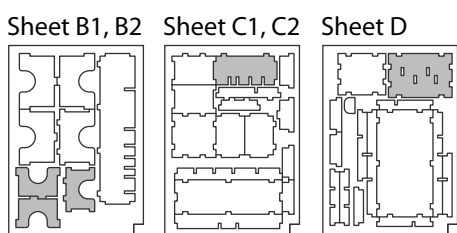

### Tray 7

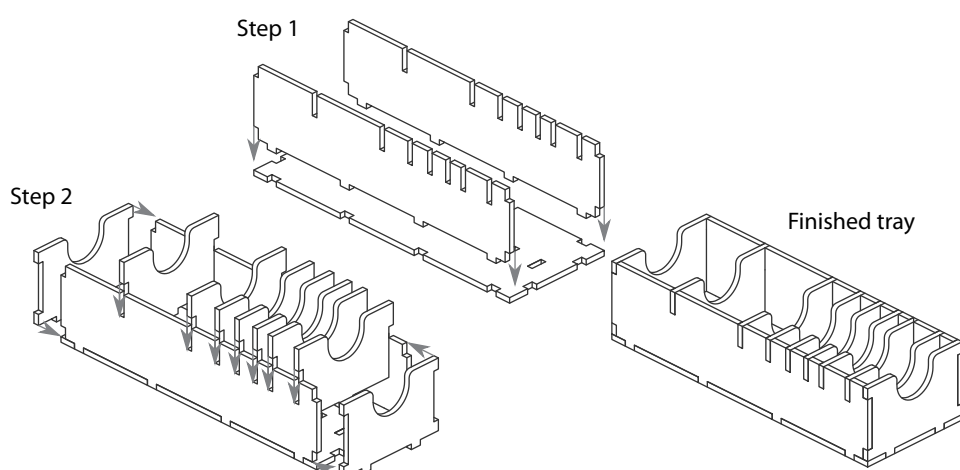
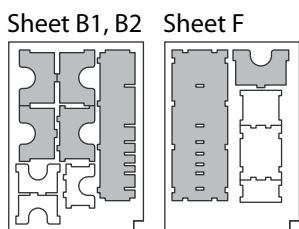

### Tray 8a, 8b

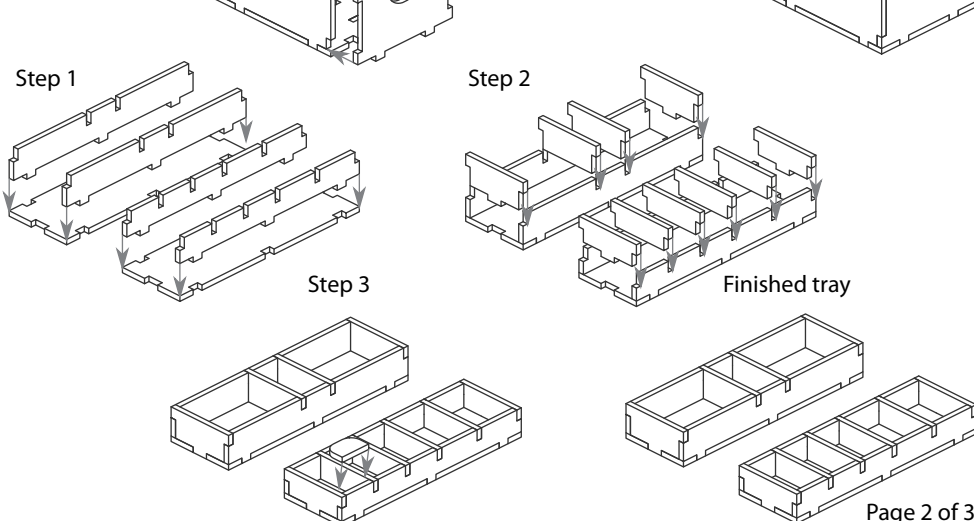
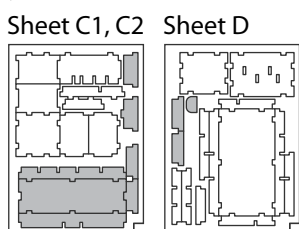

### Tray 9

Sheet D

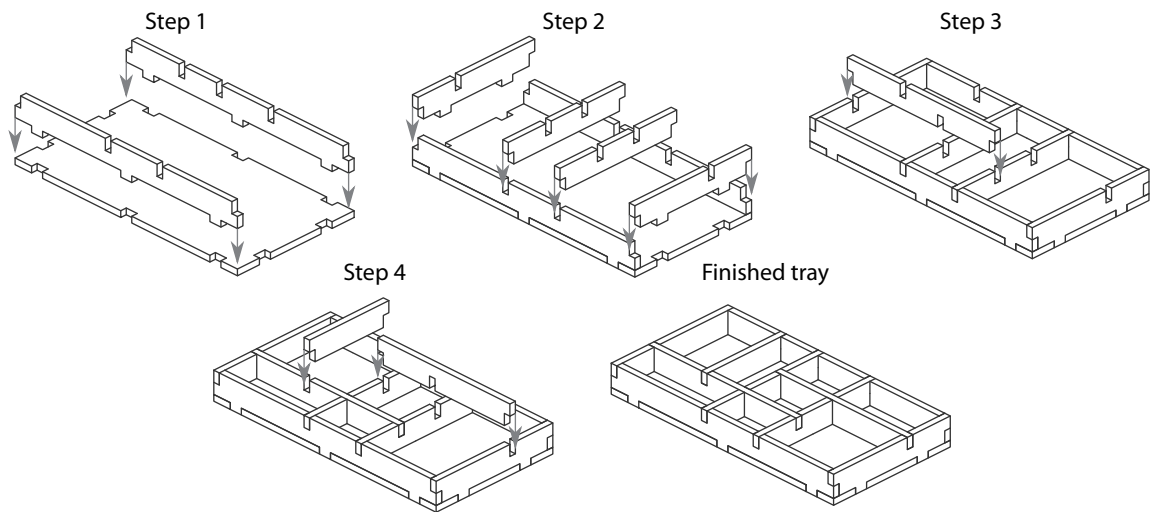
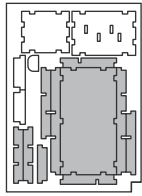

### Tray 10

Sheet E

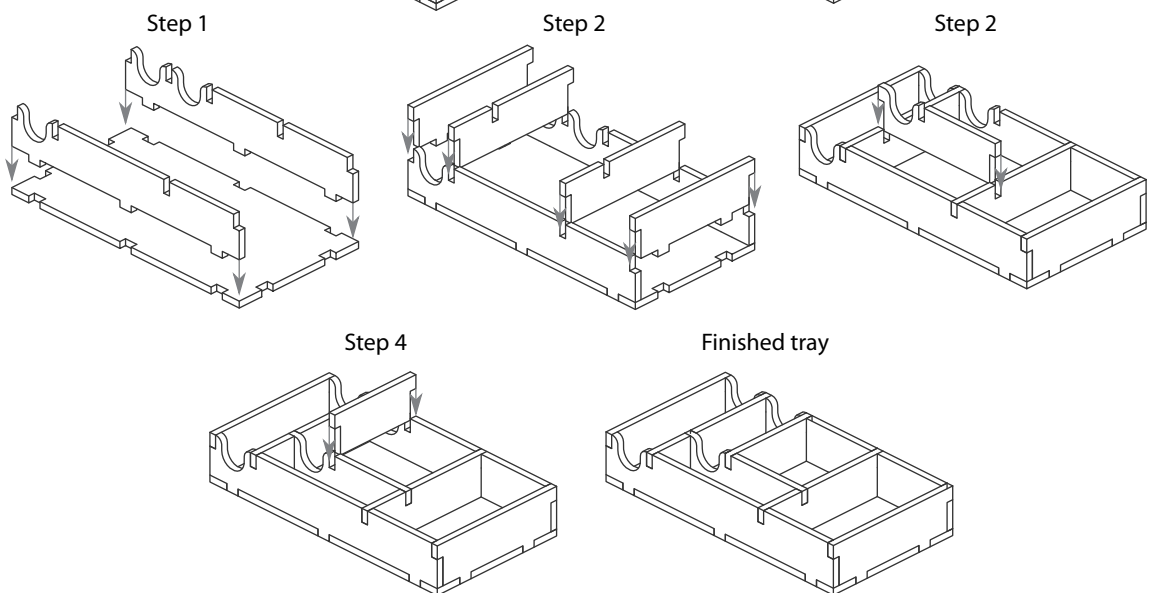
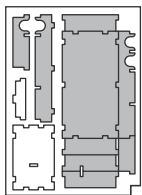

## FS-NMSLD

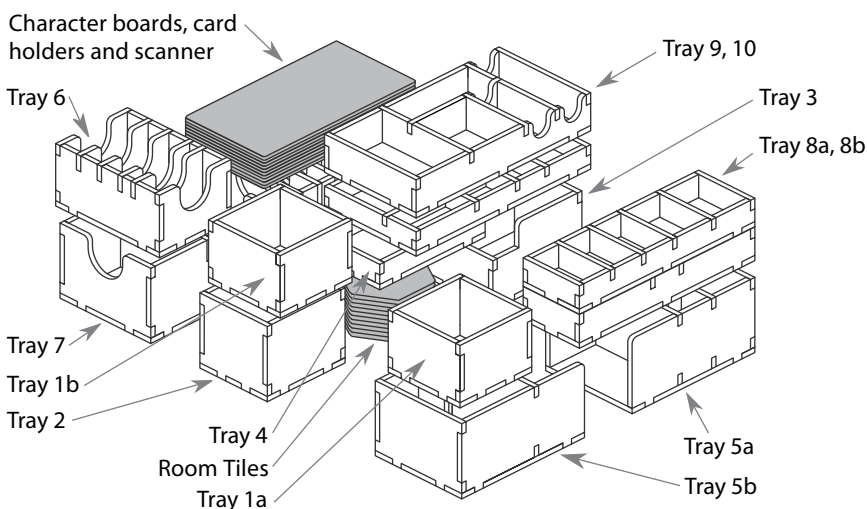

### Tray legend:

- Tray 1a - xeno creepers & squatting adults
- Tray 1b - plastic doors
- Tray 2, 3 - xeno adults
- Tray 4 - dice and other tokens
- Tray 5a, b - xeno adults, breeders, queens, main gate and rover
- Tray 6 - item, night stalker and other mini cards
- Tray 7 - all standard sized card decks
- Tray 8a - card doors with stands, first player marker, and spore & mycelium markers
- Tray 8b - ammo, malfunction, fire, status, and noise markers
- Tray 9 - exploration, CSS & knowledge, egg, carcass tokens, and chytrid tokens & germinators
- Tray 10 - counter dials, character minis, deathcaps, and larvae & stinkhorns

Please check [www.foldedspace.net](http://www.foldedspace.net) for photos of this insert in use.

Note: the intruder bag, elevator and chytrid queen board are added on top of the character boards.

**Tip:** Keep the instructions in the bottom of your board game box as a reminder of how the insert fits together.